

PRELIMINARY

X8i SHORT THROW LOUDSPEAKER FOR INSTALL



- **Pristine studio sound**
- **Exceptional bandwidth-to-size ratio**
- **Streamline design**
- **Wide directivity with consistent off-axis response**
- **Clear low frequency power with L-Vents**
- **Weather resistant IP55**



POINT SOURCE



COAXIAL



L-VENTS

ELECTRO-ACOUSTICS

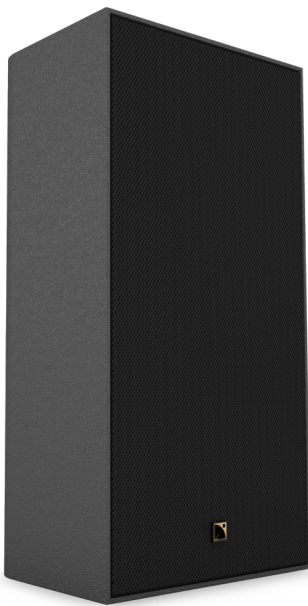

X8i is a coaxial system designed for short throw installation applications that require discretion, elegance, and yet power. The slender and streamlined design of X8i facilitates its integration in high-end architectural settings where it provides clear, studio-like sound.

The passive loudspeaker features a 1.5" neodymium compression driver coaxially loaded by an 8" low frequency transducer in a bass-reflex cabinet. This coaxial arrangement produces a 90° axisymmetric directivity with a smooth tonal response free of secondary lobes over the entire frequency range.

X8i can be driven by two presets to adapt to the acoustic needs of projects and to subwoofer coupling configurations. For strong vocal reinforcement, or when used alongside a subwoofer, the X8i preset boasts 129 dB of max SPL, down to 67 Hz. For standalone applications and close proximity listening experience, the X8i_40 preset delivers full range sound reproduction down to 43 Hz, and produces 123 dB of max SPL.

The combination of pristine yet powerful sound and elegant form makes X8i ideal for vocal or musical reinforcement in small theaters, live clubs, luxury and hospitality spaces, houses of worship, home & yacht, broadcast and recording studios.

PHYSICAL

The X8i cabinet is constructed of premium grade Baltic birch and beech plywood to ensure maximum acoustical and mechanical integrity. The slender enclosure weighs 11 kg / 24 lb and houses all mounting points and terminal block connectors at the rear of the loudspeaker leaving all other faces discrete and elegant.

The cabinet is designed to offer monitoring orientations, with three natural angles: 0°, 35°, and 55° with regard to vertical.

The large set of installation-friendly accessories offers a premium integration solution, reinforced by the RAL custom-colored program to blend into all types of decor.

The weatherized X8i features terminal connectors behind a connector sealing plate, enabling it to reach an IP55 rating, making it ideal for outdoor operation.



Sleek and discrete design with all mounting points and speaker connectors at the rear

APPLICATIONS

Coaxial loudspeakers generate a wide conical directivity pattern with excellent spatialization and no minimum listening distance. The coaxial technology and the combination of power and bandwidth make X8i ideal for most short throw applications, from the main system in a small House of Worship, to fill enclosures in small to medium theaters. The elegant X8i enclosure and the multiple mounting options also offer a discrete and premium solution for hospitality settings, in live clubs, home & yacht, or studios.

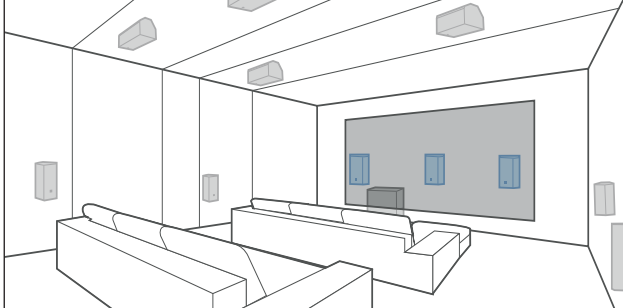

Main system in home cinema setting

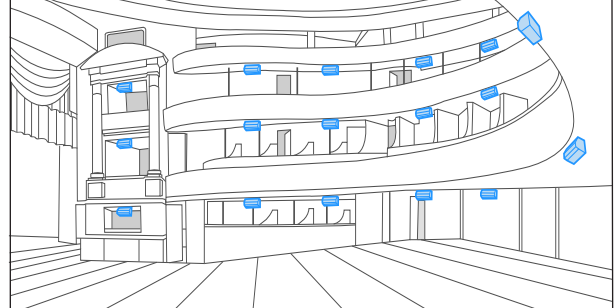

Distributed fill system in theaters or performing art centers

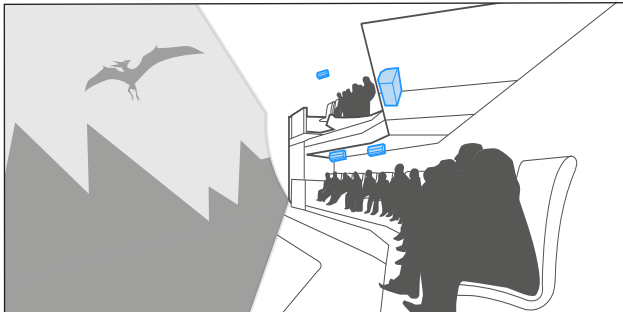

Main or fill system in theme parks

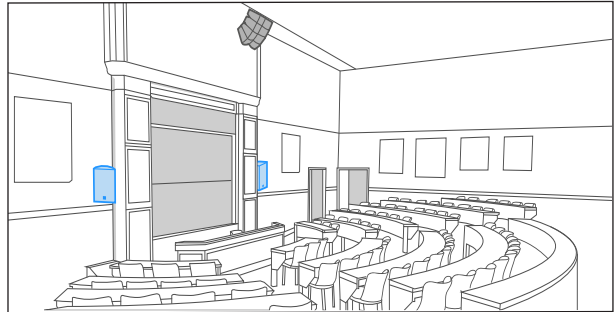

Fill system in lecture halls

RIGGING

X8i can be mounted on the wall vertically or horizontally with silent blocks to prevent structural vibration that can result in unwanted noise transmission. Specific accessories allow for Pan and Tilt orientation, ground stacking, or even pole mounting.

ON-WALL



X8i-onCW
On-Ceiling/Wall mounting with silent blocks



WALLx2
Wall-mounting without silent blocks



TILT / TILT5 / TILT15 / TILT40
On-wall mounting (Requires TILT-SUPPORT accessory)

ON-CEILING / ON-WALL



X8i-HBAR
On-ceiling mounting



VBAR
On-ceiling mounting (Can be combined with TILTs accessories)



PAN
On-wall mounting (Requires TILT-SUPPORT accessory)

MISC



CEILING-PENDANT

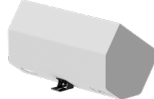

GROUND / GROUND35 / GROUND55
Ground mounting







POLE + SPCON
Pole mounting + speakON adapter



PAN + TILT
On-wall mounting (Requires TILT-SUPPORT accessory)

AMPLIFIED CONTROLLERS

LA2Xi and LA4X are the recommended amplified controllers with one or two X8i per output channel. For multi-channel configurations, LA7.16i offers the most efficient amplification solution.

Amplified controllers	LA7.16i	LA2Xi	LA4X	LA12X
Front and back panels				
Install / Touring	Install	Install	Install / Touring	Install / Touring
In x Out	16 x 16	4 x 4 / 4 x 3 / 4 x 2 / 4 x 1	4 x 4	4 x 4
Output power (W RMS) @ 16 ohms @ 8 ohms @ 4 ohms @ 2.7 ohms	16 x 700 W 16 x 1300 W 16 x 1100 W	4 x 200 W 4 x 360 W 4 x 640 W	4 x 1000 W 4 x 1000 W	4 x 1400 W 4 x 2600 W 4 x 3300 W
Height	2U	1U	2U	2U
Weight	14.5 kg / 32 lbs	4.40 kg / 9.70 lbs	11.3 kg / 24.9 lbs	14.5 kg / 32 lbs
Drive capability				
Max. number of enclosures per channel	1	2	2	3
Max. number of enclosures per amplifier	16	8	8	12
Max SPL (Preset X8i)	129 dB	125 dB	129 dB	129 dB

SUBWOOFER

Syva Sub: compact subwoofer (1 x 12")

Syva Sub + X8i: 27 Hz – 20 kHz
Max SPL of X8i preset is 129 dB
Ratio of 1 subwoofer to 1 X8i
Contour reinforced by 10 dB at 50 Hz



SB10: ultra-compact subwoofer (1 x 10")

SB10 + X8i_40: 27 Hz – 20 kHz
Max SPL of X8i_40 preset is 123 dB
Ratio of 1 subwoofer to 1 X8i
Contour reinforced by 10 dB at 50 Hz



SOFTWARE

SOUNDVISION: simulation software



3D electro-acoustic & mechanical simulation software

LA Network Manager: control & monitoring software



Real-time control and monitoring up to 253 units
Multiple network topologies

Xi series: Elegance and performance for premium installations



The Xi Series is a range of installation-focused coaxial enclosures with distinct formats, bandwidth, SPL and coverage angles adapted to short throw applications. With pristine sound quality and discreet design, the Xi Series integrates elegantly in venues in search of natural and powerful sound.

Coaxial technology allows for a compact design and constant tonal balance over distance, giving the Xi Series smooth coverage for off-axis audiences, no minimum listening distance and high feedback rejection.

COVERAGE

About coaxial technology

In 1989, L-Acoustics introduced the first coaxial loudspeaker enclosure for professional sound reinforcement, bringing studio quality to near-field applications for the first time. Since then, coaxial technology has been implemented in all L-Acoustics point sources.

A coaxial design approach aligns LF and HF acoustic centers to achieve a single point source radiation with coherent wavefront at all frequencies, that is free of polar lobing effects, typical of traditional horn and woofer combinations. This results in natural, studio monitor sound quality, ideal for proximity use.

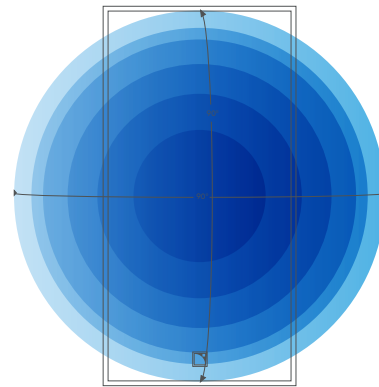
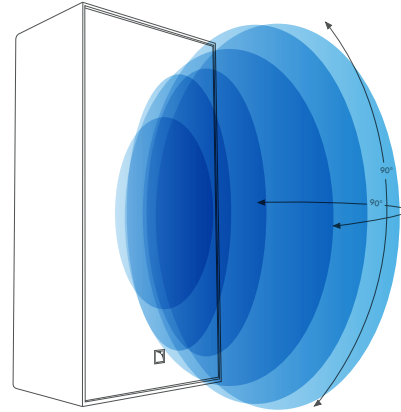
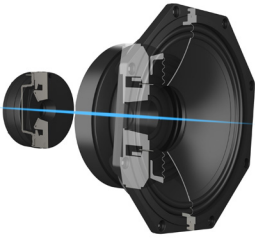

BEAMWIDTH

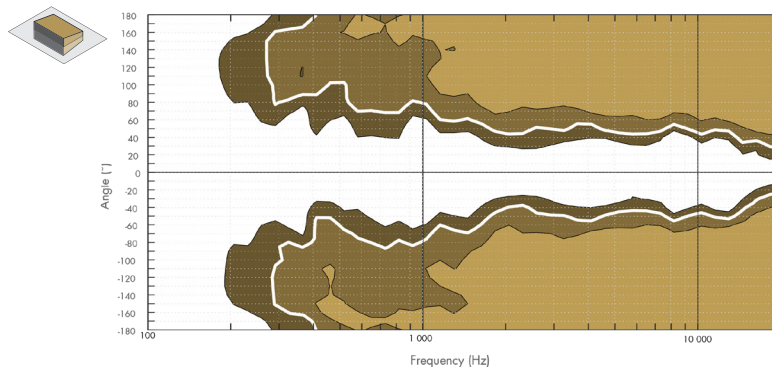
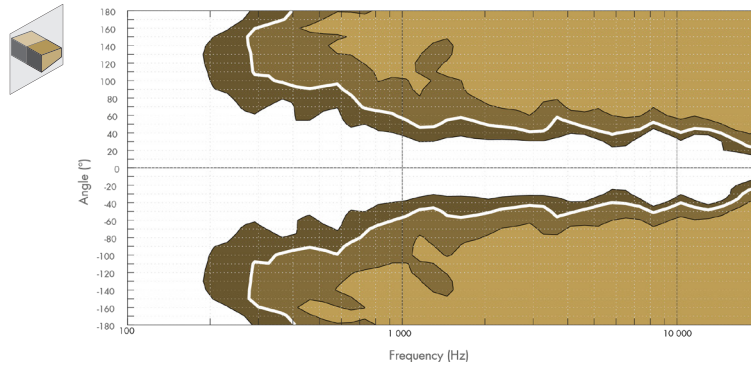

► Dispersion angle diagram of a single X8i in vertical (top) and horizontal (bottom) plane using lines of equal sound pressure at -3 dB, -6 dB, -12 dB.

PRELIMINARY

X8i SHORT THROW LOUDSPEAKER FOR INSTALL

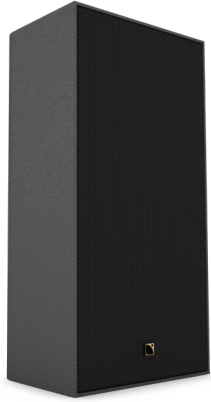

X8i is a point source system designed for short throw installation applications. Part of the Xi Series, X8i is an 8" format loudspeaker that provides high output, broad bandwidth, and immaculate sound in an elegant and discreet enclosure.

X8i is a two-way passive enclosure with transducers mounted coaxially to produce a 90° axisymmetric directivity with a smooth tonal response free of secondary lobes over the entire frequency range. X8i can be used with two dedicated presets, one with a focus on bandwidth and the other on SPL.

The combination of a streamlined design with a plethora of accessories, the RAL custom-color program, and IP55 make for easy integration in any decor indoor or outdoor.

On its own, X8i is ideal for vocals or as a complement to larger systems, for fill applications in performing arts centers, houses of worship, corporate facilities, and studios.

Supplemented by a subwoofer, the combination of pristine yet powerful sound and elegant form makes X8i ideal for musical reinforcement in small theaters, live clubs, luxury and hospitality spaces, home & yacht, broadcast and studios, or as the main system in a home cinema setting.



SPECIFICATIONS

Description	2-way passive coaxial enclosure amplified by LA7.16(j) / LA2Xi / LA4X / LA12X	
Preset	[X8i_40]	[X8i]
Usable bandwidth (-10 dB)	43 Hz - 20 kHz	67 Hz - 20 kHz
Maximum SPL^{1,2}	123 dB	129 dB
Nominal directivity (-6 dB)	90° axisymmetric	
Monitor angle³	35° / 55°	
Transducers	LF: 1 x 8" HF: 1 x 1.5" neodymium compression driver	
Acoustical load	Bass-reflex, L-Vents	
Nominal impedance	8 Ω	
Connectors	4-point terminal block with push-in connection and connector sealing plate	
Rigging and handling	8 M6 inserts	
Weight (net)	11 kg / 24 lb	
Cabinet	Premium grade Baltic birch and beech plywood	
Front	Steel grill with anti-corrosion coating	
Finish	Dark grey brown Pantone 426C Pure white RAL 9010 Custom RAL code on special order	
IP	IP55	

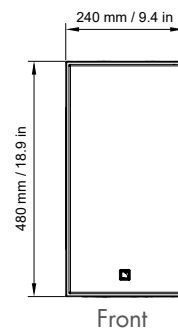

Front

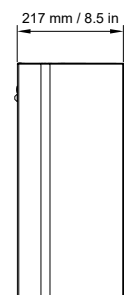

Side

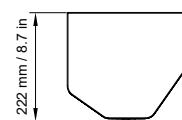

Top

¹ - Peak level at 1 m under free field conditions using pink noise with crest factor 4 (preset specified in brackets).

² - For Max SPL values using LA2Xi, refer to LA2Xi system specification sheet.

³ - With regard to vertical

SB10 ULTRA-COMPACT SUBWOOFER



Description	Ultra compact subwoofer: 1 x 10" amplified by LA7.16i / LA2Xi / LA4X / LA12X		
	Preset [SB10_60]	Preset [SB10_100]	Preset [SB10_200]
Low frequency limit (-10 dB)	25 Hz	27 Hz	29 Hz
Maximum SPL^{1,2}	119 dB	122 dB	124 dB
Nominal directivity	Standard		
Transducers	1 x 10" cone driver		
Acoustical load	Bass-reflex, L-Vents		
Nominal impedance	8 Ω		
Connectors	4-point terminal block with push-in connection and connector sealing plate		
Rigging and handling	SB10i: 12 x M6 inserts for on-wall and on-ceiling accessories (SB10i-onCW) SB10r inWall / inCeiling / inTile recessed versions		
Weight (net)	14 kg / 31 lb		
Cabinet	Premium grade Baltic birch plywood		
Front	Coated steel grill Acoustically neutral 3D fabric		
Finish	Dark grey brown Pantone 426 C Pure white RAL 9010 Custom RAL code on special order		
IP	IP55		

¹ Peak level at 1 m under half space conditions using pink noise with crest factor 4 (preset specified in brackets).
² For Max SPL values using LA2Xi, refer to LA2Xi system specification sheet.



DIMENSIONS

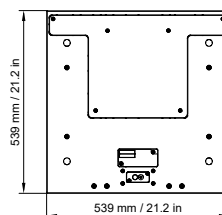
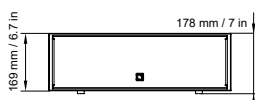

Bottom

SYVA SUB PERFORMANCE ART



L-VENTS

Description	Infra low frequency subwoofer: 1 x 12" amplified by LA7.16(i) / LA2Xi ² / LA4X / LA12X	
	Preset ([SYVA SUB_100])	Preset ([SYVA SUB_200])
Low frequency limit (-10 dB)	27 Hz	29 Hz
Maximum SPL¹	128 dB	130 dB
Nominal directivity	Standard	
Transducers	1 x 12" conde driver	
Acoustical load	Bass-reflex, L-Vents	
Nominal impedance	8 Ω	
Connectors	IN: 4-point speakON® AutoConnect	
Weight (net)	27 kg / 60 lb	
Cabinet	First grade Baltic beech and birch plywood	
Front	Steel grill with anti-corrosion coating Acoustically neutral 3D fabric	
Finish	Fine grain dark grey brown Pantone 426C Pure white RAL 9010 Custom RAL code on special orde	
IP	IP55	

¹ Peak level at 1 m under half space conditions using pink noise with crest factor 4 (preset specified in brackets).

² For Max SPL values using LA2Xi, refer to LA2Xi system specification sheet.



► Vertical



► Horizontal



► Syva + Syva Sub

DIMENSIONS

